



# COX DOME Brakel® MonoTherma



## Single flap ventilator

The Mono Therma is a single flap system suited for both smoke & heat extraction and daily ventilation. This system is highly air and watertight. The countless options available in terms of the base and flaps, as well as numerous operating systems and accessories, enable the creation of a functional solution for any type of building: From industrial properties to cold stores, and from commercial centres to theatres and offices premises.



The cold bridge-free Mono Therma TG fitted with a thermally separated base and flaps offers a high level of durability. It minimises condensation forming and offers advanced comfort features. In the event that sound insulation is also required, two fully acoustic versions of the Mono Therma TG model are available, which have Rw values of 34 dB and 44 dB.

## Green Building Products

As a leading partner in its field, Brakel endeavours to remain a forerunner in the area of corporate social responsibility. Given that with our products, we let in the best that nature has to offer, it is only natural that we also care greatly for the environment. We therefore seek to integrate sustainable solutions in our working methods, products and services, wherever possible.

We have categorised our highly extensive product range according to the levels of sustainability and comfort applicable. The many energy efficient products and systems in the range can be recognised by the butterfly icons that they bear.

We classify our products, ranging from functional to sustainable, as follows:



functionally applicable in accordance with current qualifications / standards



compliant with raised sustainability requirements



compliant with high sustainability requirements



entirely in keeping with a sustainable solution

### Mono Therma AT uninsulated



- Sea water and corrosion-resistant aluminium EN AW 5754 (AlMg3)
- High air and watertightness
- Considerable flexibility in terms of dimensions and flange type
- Convenient installation

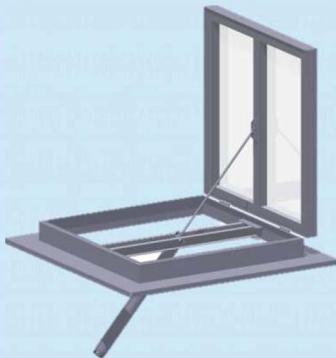

### Mono Therma AT insulated



- Optional transparent polycarbonate flaps allow daylight entrance
- Broad range of operating systems and accessories available
- Suitable for all types of buildings and roof applications

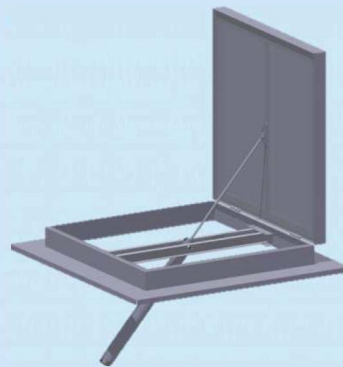

# Specifications Mono Therma

EN 12101-2 CERTIFIED

Type	Throat size width x length (mm)	Geometric surface m <sup>2</sup>	Aerodynamic surface m <sup>2</sup>	Cv-value	Height mm TG Acoustic =250mm	Weight (kg)							
						Mono Therma (un)insulated				Mono Therma TG Thermally broken			
						Uninsulated aluminium	Insulated aluminium	Transparent multi-wall polycarbonate Isolux	Single laminated safety glass	Insulated aluminium	Transparent multi-wall polycarbonate Isolux	Laminated insulation glass	Acoustic insulated
1010	1000 x 1000	1	0,6	0,6	200	31	41	32	63	44	43	72	88
1015	1000 x 1500	1,5	0,9	0,6	200	38	49	39	80	53	51	93	120
1020	1000 x 2000	2	1,2	0,6	200	45	57	46	98	62	59	115	153
1025	1000 x 2500	2,5	1,5	0,6	200	52	65	53	116	72	68	137	185
1210	1250 x 1000	1,25	0,75	0,6	200	34	45	35	72	49	47	83	104
1215	1250 x 1500	1,88	1,13	0,6	200	41	53	42	92	59	56	108	142
1220	1250 x 2000	2,5	1,5	0,6	200	49	62	50	112	69	64	133	180
1225	1250 x 2500	3,13	1,88	0,6	200	56	71	57	132	79	73	158	218

*Comment: The Cv-value of the Mono Therma is tested in combination with wind baffles. Deviations can be made depending on the situation in which it is installed.*

## Mono Therma TG thermally separated

- Entirely thermally separated base and flaps
- Extensive choice of flap types
- Standard noise reduction (Rw) of 31 dB
- Increased level of comfort, with U-values of up to 1.0 W/m<sup>2</sup>K
- Air and watertightness tested accordance NEN EN 1026 / 1027 and DIN EN 12208

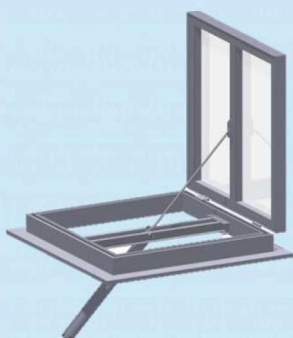

## Mono Therma TG thermally separated / acoustically insulated

- Thermally separated base and flaps, with additional acoustic insulation
- Compliant with highly stringent acoustic requirements
- U-values of up to 0,9 W/m<sup>2</sup>K

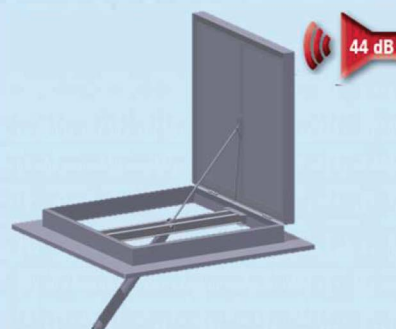

## Materials

**Base and flanges:** Sea water and corrosion-resistant EN AW 5754 (AlMg3) sheet aluminium is used in the Mono Therma AT models; the Mono Therma TG models are made of EN AW 606035 (AlMgSi0,5) extruded profile sections which are thermally separated.

**Sealing:** All-round, using coated EPDM rubbers, which prevent freezing while guaranteeing a high level of airtightness.

**Hinges:** Stainless steel.

**Flaps:** With or without thermal separator  
Choice of: uninsulated or mineral wool-insulated aluminium flap, 16 to 55 mm transparent multi-wall polycarbonate filler, single safety glass, insulated safety glass, or a high quality acoustically insulated flap.

**Finishing:** Standard blank aluminium or coated in a standard RAL colour.

## Controls

**P2:** Double-action compressed air operation

**M :** Motor operation

Optional: **B:** including fire function      **FS:** failsafe

## Accessories

- Bird or insect mesh
- Fall protection
- Burglary prevention features
- Insulated flanges
- RAL colour / Anodised

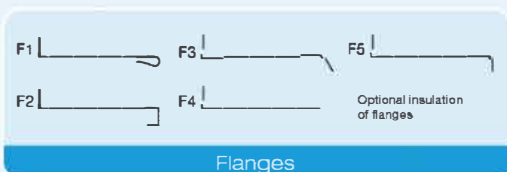
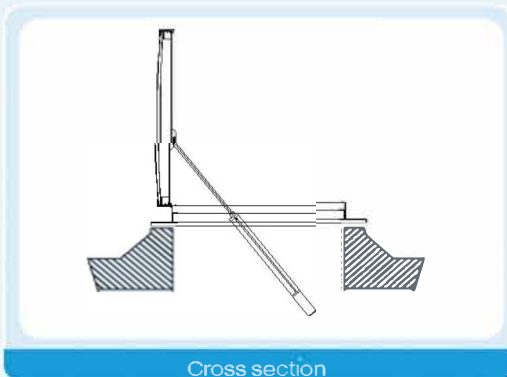

AT-flaps		U-value W/m² K
	Uninsulated	6,0
	Single laminated glass	5,7
	Insulated	2,0
	Isolux 16 mm	1,8 - 2,3
TG-flaps		U-value W/m² K
	Thermally broken insulated	2,0
	Thermally broken Isolux 16 mm	1,8 - 2,3
	Thermally broken laminated insulation glass	1,1 - 2,8
	Thermally broken Isolux 55 mm	1,0
	Thermally broken acoustic insulated	0,9

Flaps

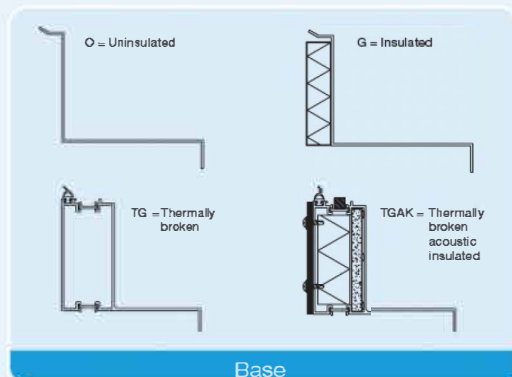

For further information, go to our website: [www.brakel.com](http://www.brakel.com)